



RADIO ASTRONOMY

SOLAR ECLIPSE on 20 March 2015

Radio observations, analysis and results

By Jean-Jacques MAINTOUX – F1EHN / F6KSX – AAV

In collaboration Joachim DF3GJ / DL0SHF

Last update : 23 May 2015

Solar Eclipse on 20 March 2015

Observation, analysis and results

- F6KSX – AAV radio astronomy station (radio telescope)
- Expected performance
- Forecast of the solar eclipse
- Measurements - Analysis and results
- Simulation - Analysis and results
- Conclusions
 - References

F6KSX – AAV Station – Radio telescope

- Parabolic dish antenna : 3.3m diameter – Vertical Linear Polarization
- Frequency band : 21cm (dedicated to radio astronomy)
- System Noise Temperature : 60 K
- Digital receiver on IF 60 MHz / Bw=2,5 MHz(sample frequency)
- Realtime display with Funcube device and Spectravue



Real time display and signal post-processing



- ❑ GPS – Timing and Frequency reference
- ❑ Data recording and automatic tracking
- ❑ Local Oscillator for 21cm receiver
- ❑ Tracking interface for positioning system

Expected performances

Soit T = Temperature, k = Boltzmann cst, $cs \Rightarrow$ cold sky, $sun \Rightarrow$ sun, $sys \Rightarrow$ system, $F = 1420$ MHz, wavelenght $\lambda = c/F \Rightarrow \lambda = 0.211m$, A_{eff} = effective Area, Bw = Bandwidth

■ 21cm STATION :

□ Antenna @21cm

- $D = 3.3m$, Gain = 31dBi $\Rightarrow G = 1260$
- $A_{eff} = G \cdot \lambda^2 / 4\pi = 4,46 \text{ m}^2$
- Diagram aperture = $4,4^\circ$ (half power beamwidth - HPBW)
- $T_{ant_cs} = 15K$ ($T_{sky} \sim 5K$, $T_{lobes} = 10K$ + spillover estimated from measurement)

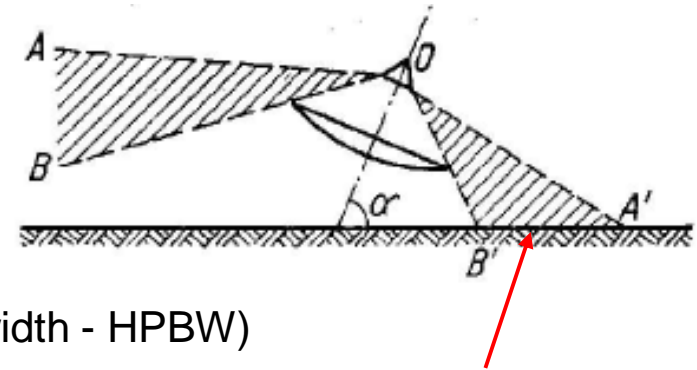

□ Receiver

- L_r = antenna to receiver losses = 0,1 dB $\Rightarrow L_r = 1,023$
- Receiver Noise temperature : $T_r = 34K$ (NF = 0,48 dB).
- $Bw = 2.5$ MHz (to enhance measurement resolution)

□ System temperature

- $T_{sys_cs} = T_{ant_cs} + (L_r - 1) \cdot 290K + L_r T_r$ (cold sky @ $\sim 5K$)
 - ✓ **$T_{sys_cs} = 57 \text{ K}$** (cs = Cold sky / near galactic poles)

$T_{ant} \Rightarrow$ Antenna temperature, $T_{sys} \Rightarrow$ System temperature

Expected performance

- Frequency : 1422 MHz (Away from H1 line radiation)
 - Here we are interested in the thermal radiation from the Sun (ionized gas at high temperature and black body radiation type)
 - Radio radiation is a tiny part of the solar radiation mostly centered between infra-red and ultraviolet.

□ <http://en.wikipedia.org/wiki/Sunlight>

■ Sun flux radiation

- Flux @ 1415 MHz : 85 sfu
 - From San Vito observatory (or $85 \cdot 10^{-22} \text{ W/m}^2/\text{Hz}$)

■ Expected signal level (solar excess noise)

- $T_{\text{ant_sun}} = \text{Flux} \cdot A_{\text{eff}} / (2 \cdot k) = 1374\text{K}$ (for one polarisation)
- Received signal measurement is similar to $(S+N)/N$ with :
 - $S = k \cdot T_{\text{ant_sun}} \cdot Bw$ **Both measurements done with the same bandwidth $\Rightarrow Bw = 2,5 \text{ MHz}$**
 - $N = k \cdot T_{\text{sys_cs}} \cdot Bw$
 - Solar excess noise = $(T_{\text{ant_sun}} / T_{\text{sys_cs}}) + 1 = 25$ **or $Y = 25$ ou 14 dB**

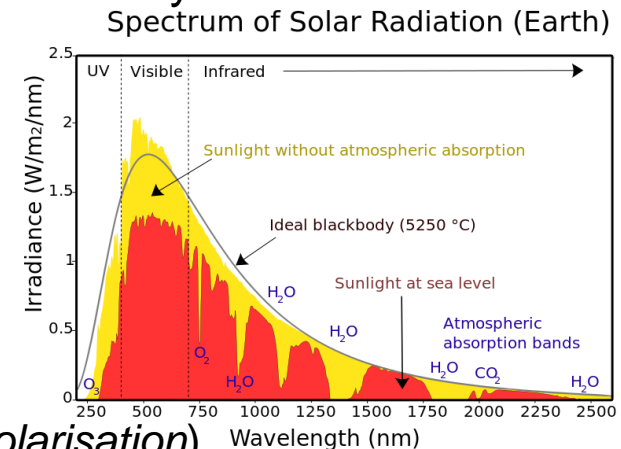

This ratio is commonly called Y factor. Here, the ratio is calculated from 2 consecutive measurements, beaming at a cold sky area and then at the sun (before and after the eclipse).

Solar Eclipse forecast

- Near Paris, this eclipse was partial with cloudy weather not permitting any optical observation. Monitoring via Internet (Pic du Midi),
- The recordings started 08:19:00 UTC. To our surprise the radio eclipse had started, contrary to predictions (see results). The elevation of the Sun was 22° at an azimuth of 118° .
- The maximum has either not been marked (see results)
- The recordings were stopped at the end of the eclipse radio around 11:00 UTC. The elevation of the Sun was near 40° for an azimuth of 160° .

Visibility of the eclipse depending on the geographical position of observation.



***That we didn't see
(in local time)***



Raw measurement

- During the eclipse, the solar flux is intercepted by the moon. Here, the temperature of the Moon is negligible (angular size low compared to the antenna aperture and still present in the lobe)

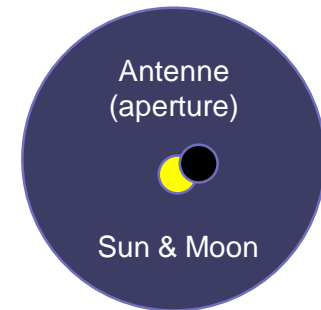
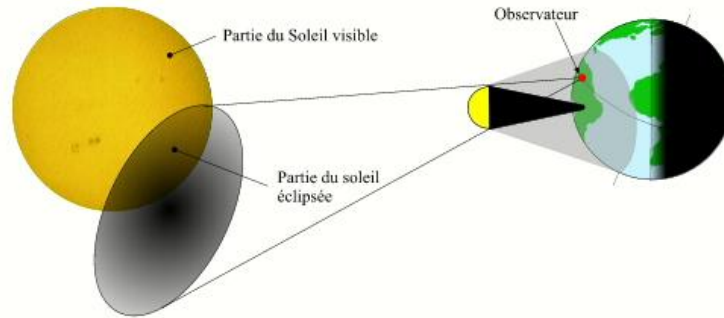

With automatic tracking of the sun position

- Raw Y factor (in dB)

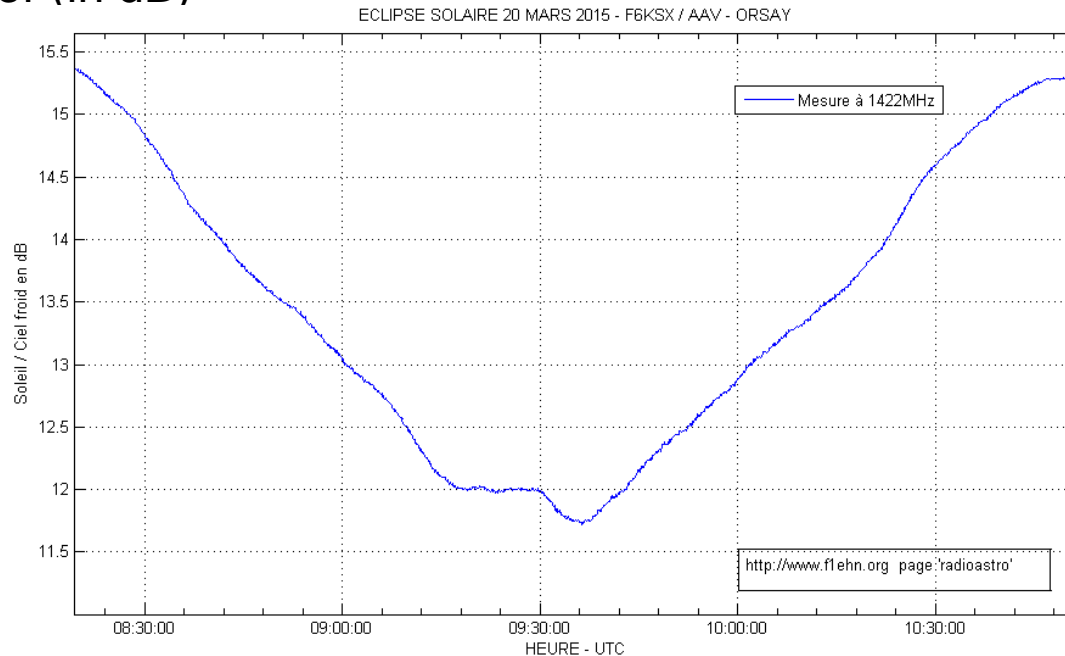

Analysis

■ System Noise Temperature (T_{sys})

- ❑ The eclipse began at low elevation. The system noise temperature is then higher, this increase is mainly linked to the sidelobes of antennas pointing near the ground, trees and surrounding homes..
- ❑ The figure below shows the system temperature depending on the elevation. The raw measurement will be corrected by taking into account the reference level measured with 'Cold Sky' without the Sun.
- ❑ The lower sensitivity brought the higher T_{sys} is then compensated..

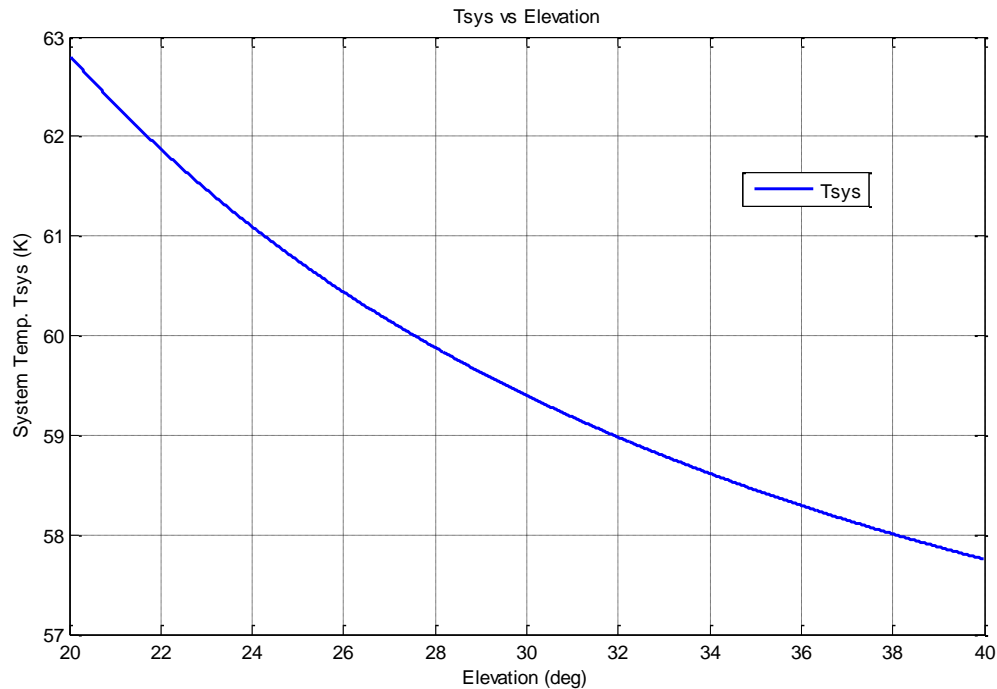

Results and comments

- The curve below shows the antenna temperature calculated from the Y factor and system noise temperature . It shows the variation of the solar flux received during the eclipse.

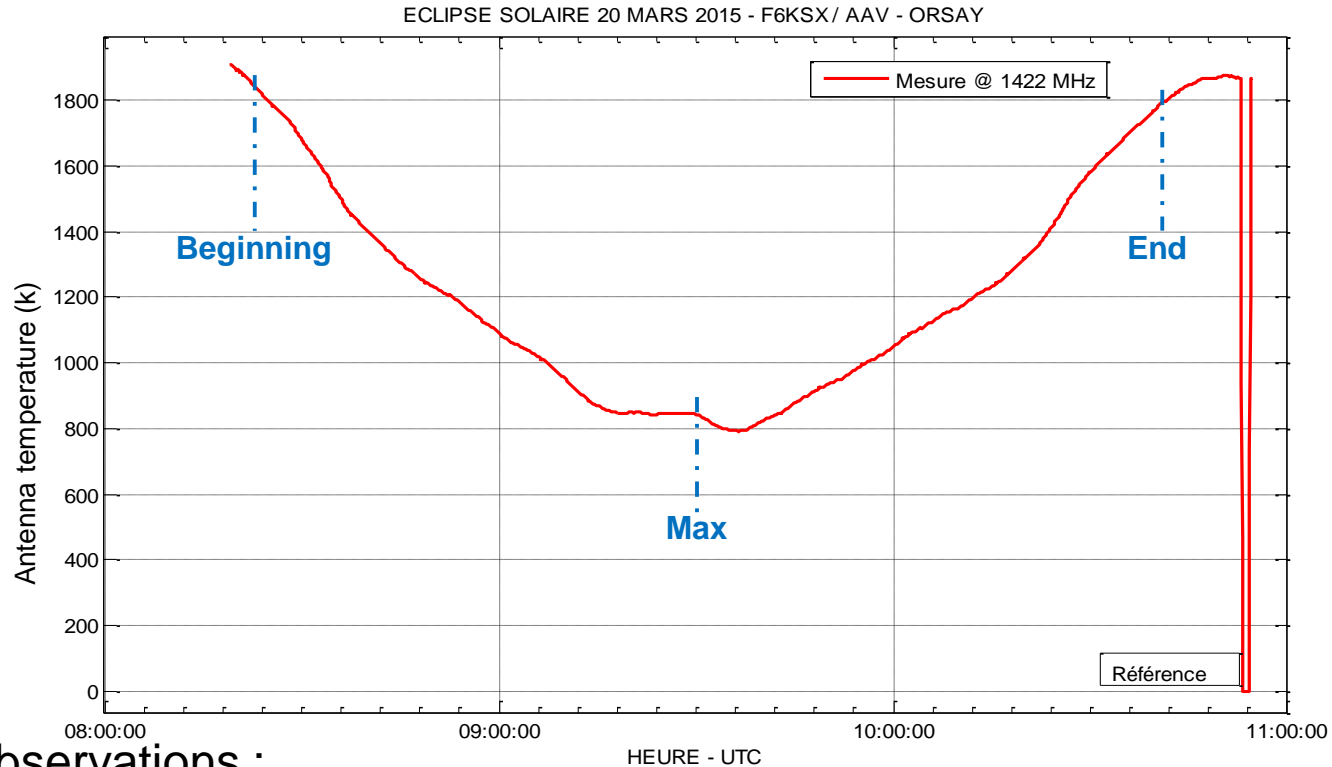

■ First observations :

- The radio eclipse is wider than the optical eclipse shown by the markers.
- The maximum of the eclipse is not marked and is less than expected (57% instead of 79% of obscuration)
- The antenna temperature is higher than expected
- The curve is not uniform and has numerous kinks on its flanks.

Results and comments

- The radio eclipse is longer and less "deep" than the optical eclipse :
 - Indeed the sun @ 21 cm can be considered as "larger". Corona extends far beyond its visible diameter and it radiates the most important flux at this frequency.
 - So, the obscuration is less because the Moon cannot completely eclipse the sun corona.
 - The curve below shows 3 simulations, for optical solar eclipse or for higher frequencies >10Ghz, with a larger Sun and then with "annular" corona and compared to the flux measurement (obscuration in dB).

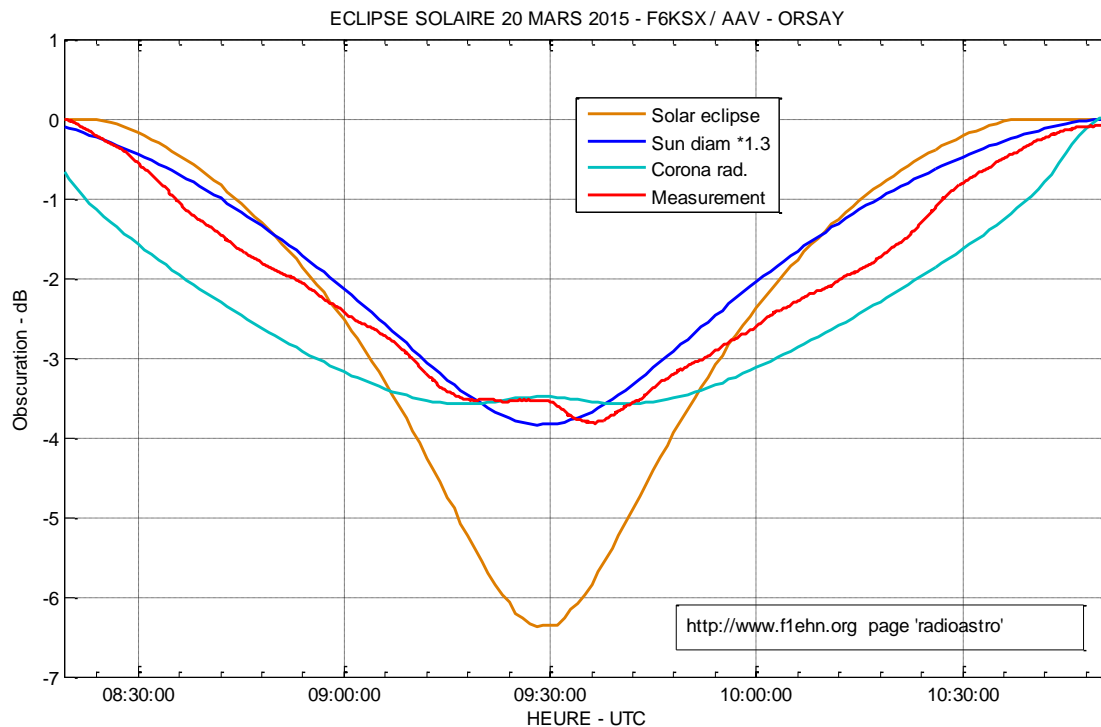

It can be seen that none of the three simulations is consistent with observation. The observation lies between annular radiation (here is too pronounced) and a larger diameter sun radiation.

More observation presents an asymmetry at the time of the maximum as well as deformations in its flanks.

Results and comments

- ❑ The antenna temperature is higher than expected
- ❑ The curve is not uniform and has numerous kinks on its flanks
- ❑ The origin may be common to these 2 comments. The presence of radiating sources, themselves eclipsed at certain moments by the Moon could cause these kinks (see simulation) and temperature rise.
- ❑ The curve below shows the Y factor in dB referenced to its maximum value. This curve allows us to identify different observed deformations and compares the results to those of the DL0SHF station and DF3GJ analysis.

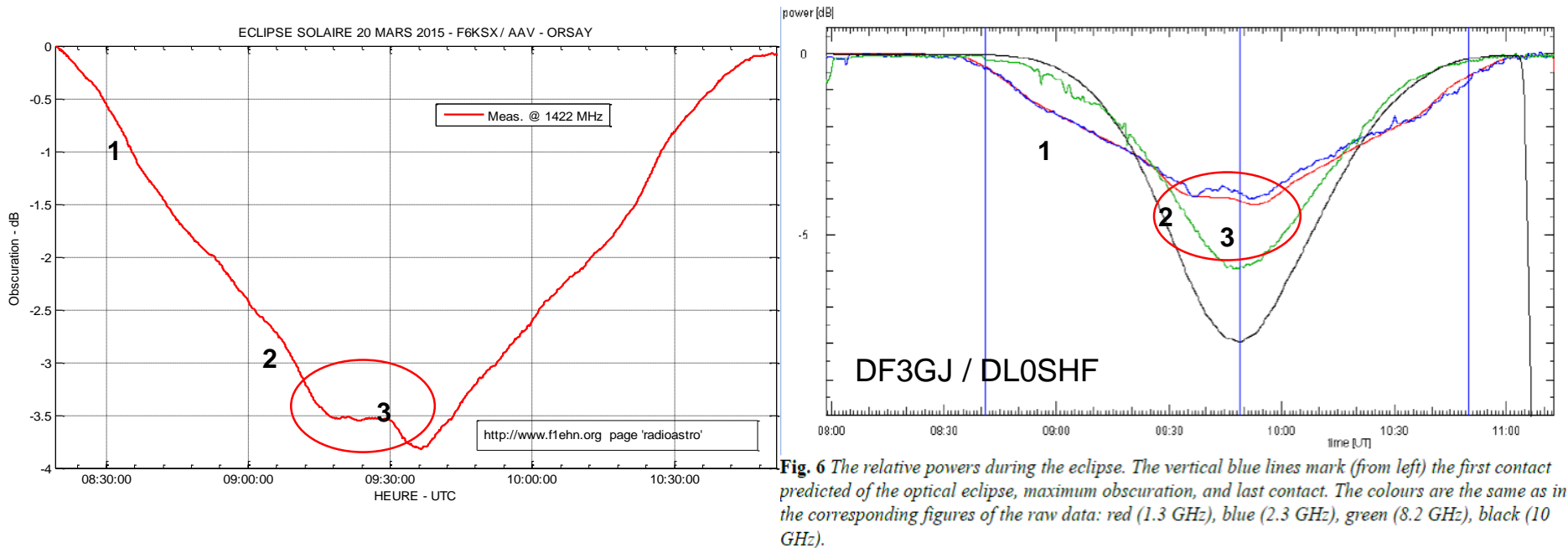
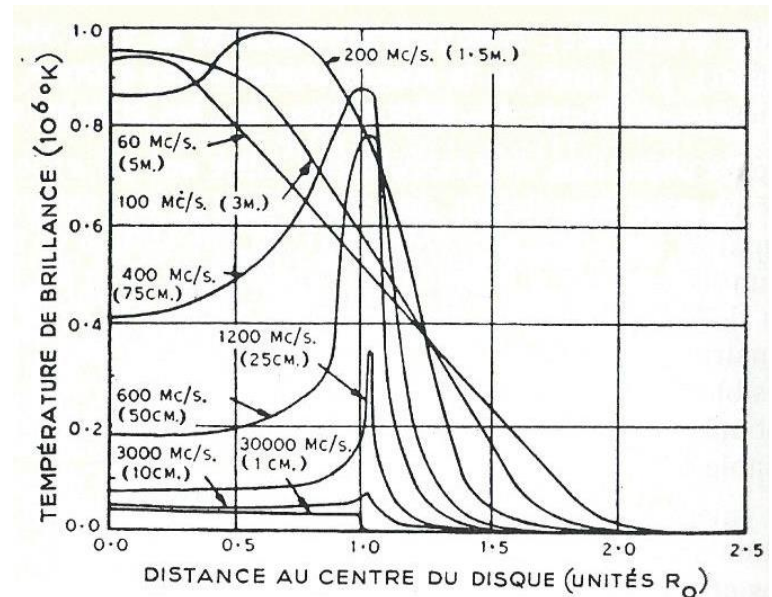
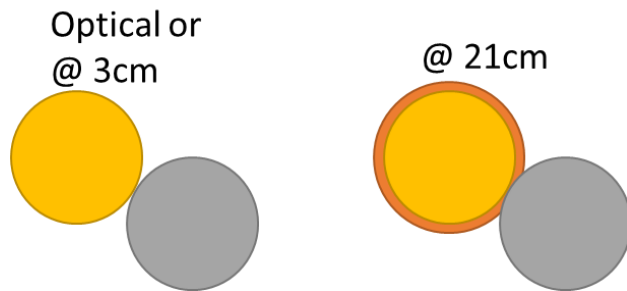

Fig. 6 The relative powers during the eclipse. The vertical blue lines mark (from left) the first contact predicted of the optical eclipse, maximum obscuration, and last contact. The colours are the same as in the corresponding figures of the raw data: red (1.3 GHz), blue (2.3 GHz), green (8.2 GHz), black (10 GHz).

It appears that the 2 stations, despite their distance and the eclipse maximum being temporally shifted, show the same phenomenon. This result is therefore not coming from a bad measurement or a local phenomenon. The observation is therefore correct. Marks 1 to 3 will be used later to identify these moments of the eclipse.

Simulations

- The measurement result lies between the simulation made with a larger diameter Sun and model considering radiation of the outer corona represented by a ring.
- The actual model is more complex (see below - Reference Coutrez). The Sun is very active and its behaviour is complex.
- Subsequently, the simulation takes into account an external diameter of the corona equal to 1.2 times the nominal diameter.
- The thermal radiation from the Sun is also taken into account.



Observations

- Other kinds of observations are considered in order to support the conclusion of the presence of several additional radiating sources.
- Thanks to the BASS2000 database, Climso Halpha videos are used to reveal bursts areas corresponding to the marks 1 to 3

- Zoom on Mark 2



- Zoom sur repère 3

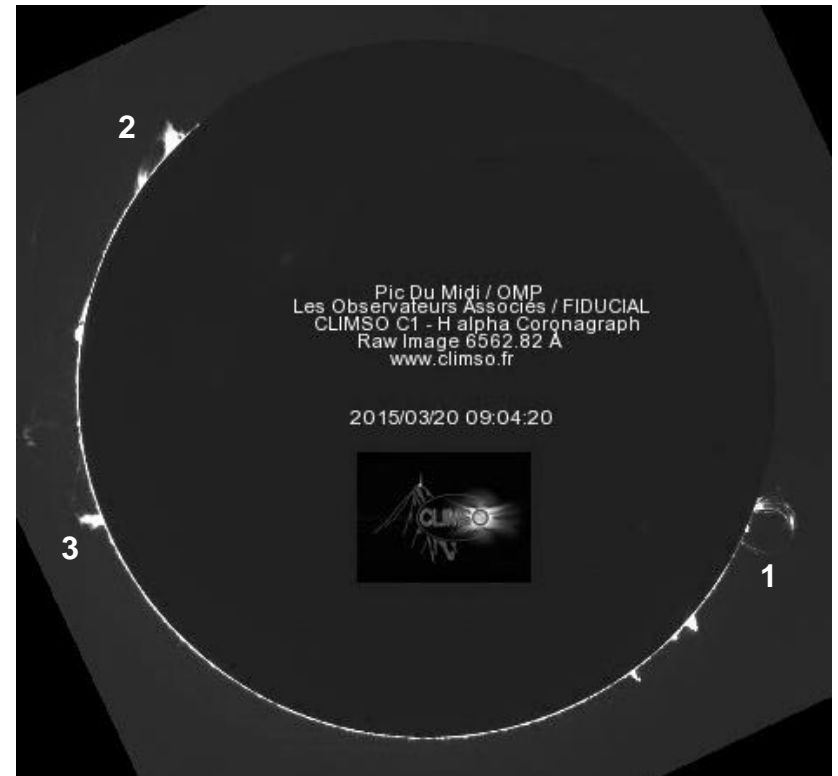

Observations

- Other observations are considered in order to support the conclusion of the presence of several additional radiating sources.
- The RATAN-600 radio telescope is used to reveal the Sun in radio. It provides surveys between 3 and 24 GHz (10 to 1.25 cm).
- The image below is extracted from the eclipse observation done by RATAN-600. The eclipse being less pronounced at that location, gives additional information on the position of the sources. For example, “1” isn’t shaded but “2” is totally shaded during the eclipse. See reference.

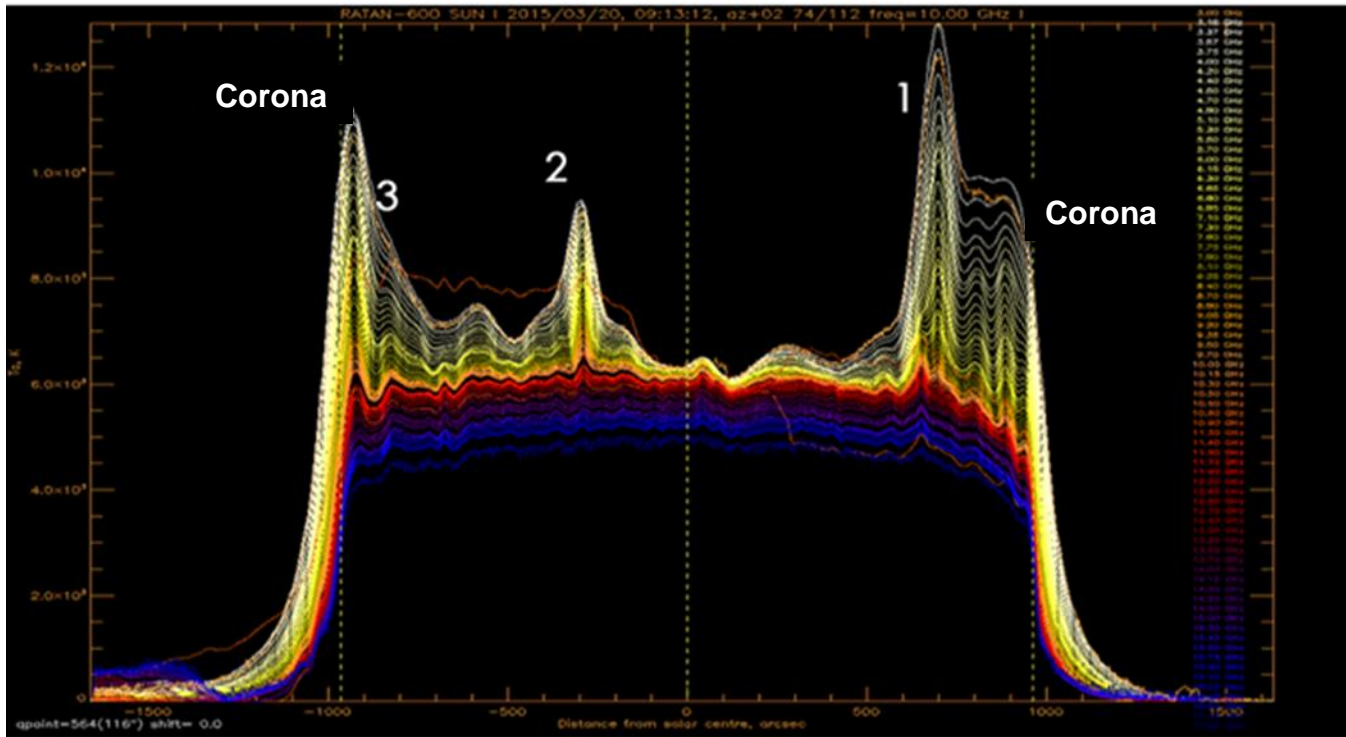

Simulations

- The analyses of observations has taken much time and the main findings are presented. From these analyses, simulations with 1, 2 or 3 radiating sources were performed. Considering the surface of the Sun is very complex, there are multiple radiating sources. We should also use more accurate models. The simulations were limited to 3 radiating sources.
- The figure below shows the progress of the eclipse and the position of the 3 sources considered.

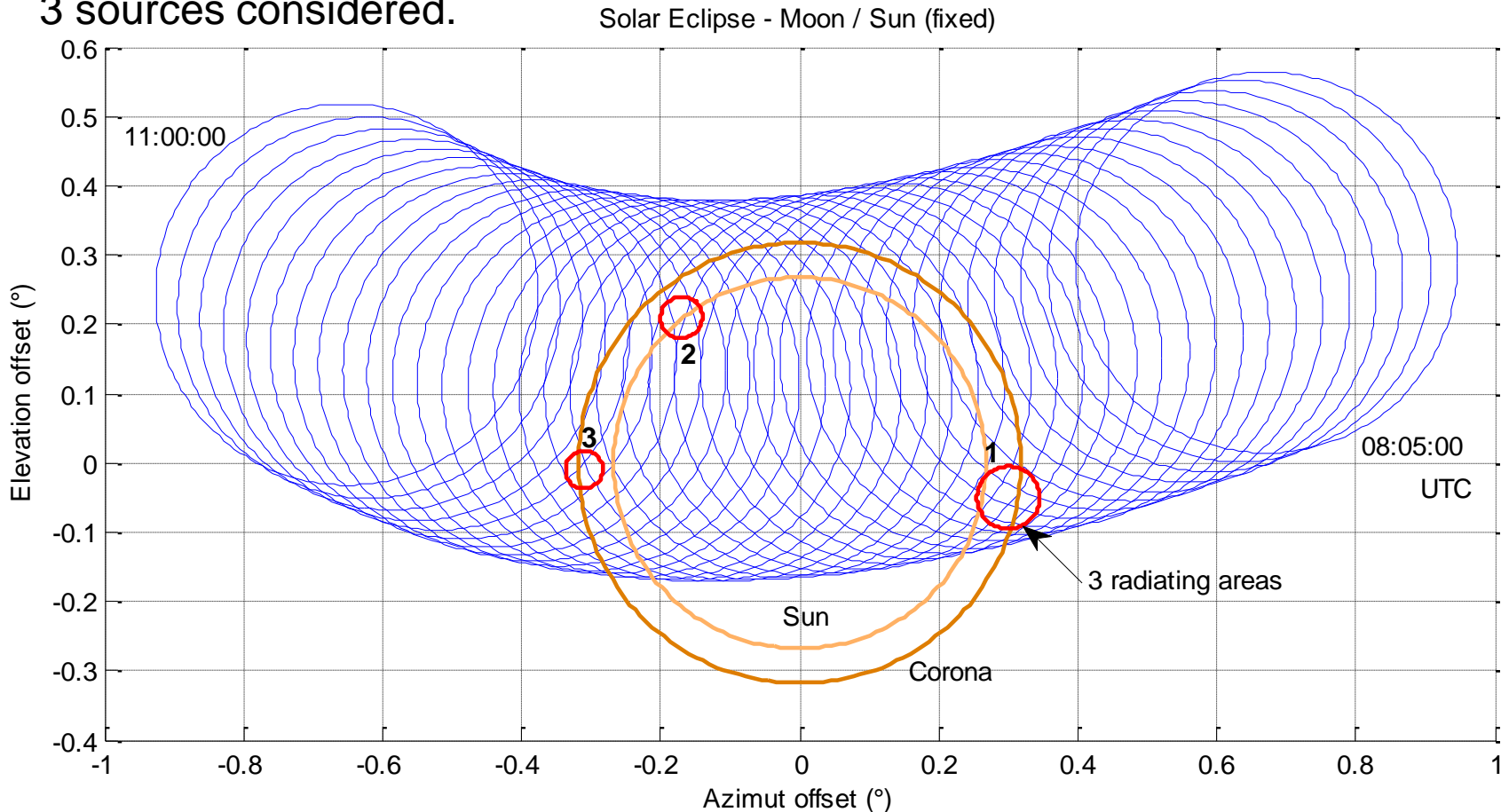

Simulations

- The simulation is broken down into different contributors.
- The figure below shows the contribution of each element to the simulation presented on the previous page.

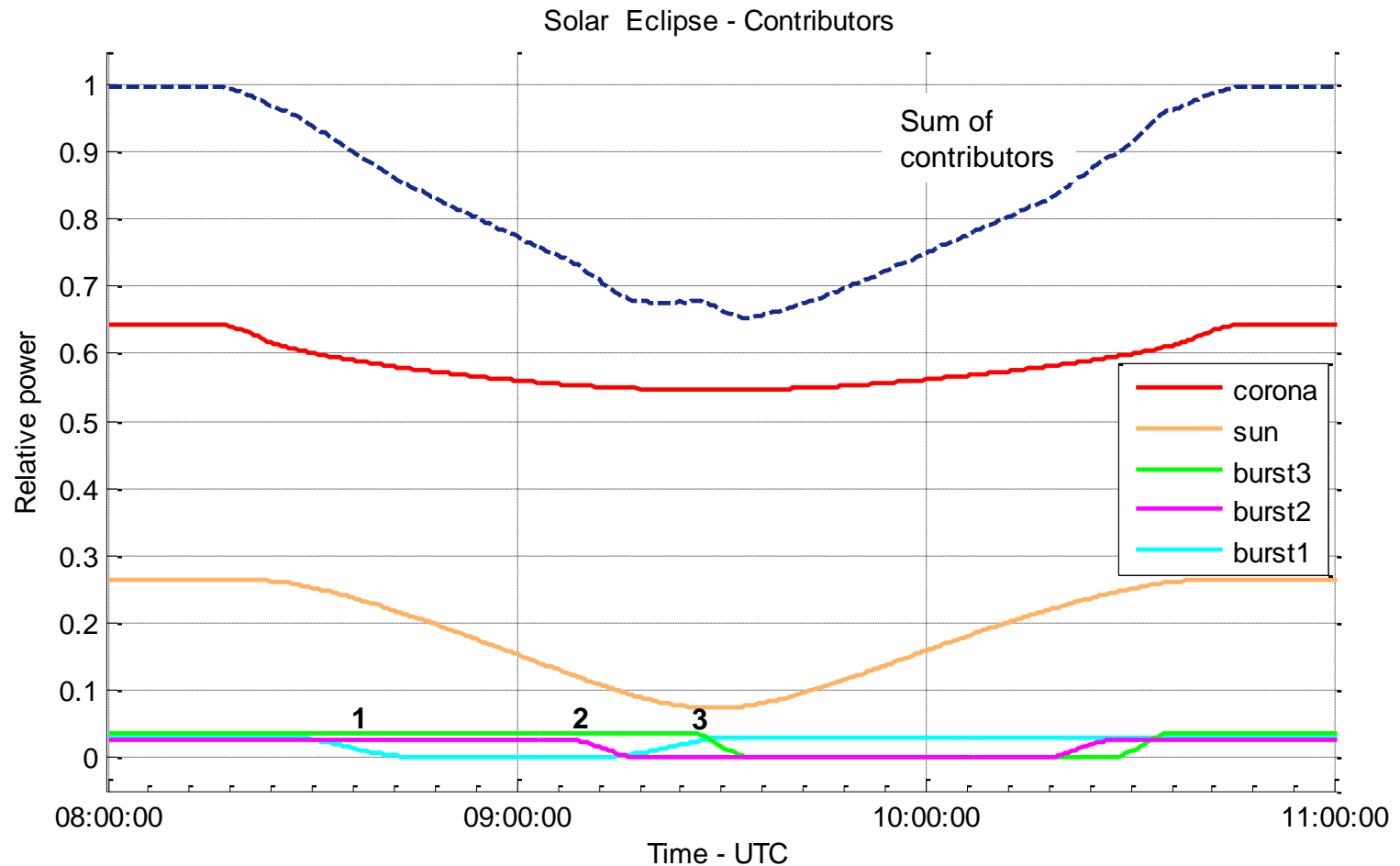

Simulations

- Simulations involving 1, 2 or 3 sources were made. 3 sources gives the following result. The number of parameters is important (temperature, position and dimensions of the radiating sources, dimensions of the corona and the corona and the sun temperature) and they are detailed at the end of this presentation.
- The figure below compares the result of simulation to the measurement.

ECLIPSE SOLAIRE 20 MARS 2015 - F6KSX / AAV - ORSAY

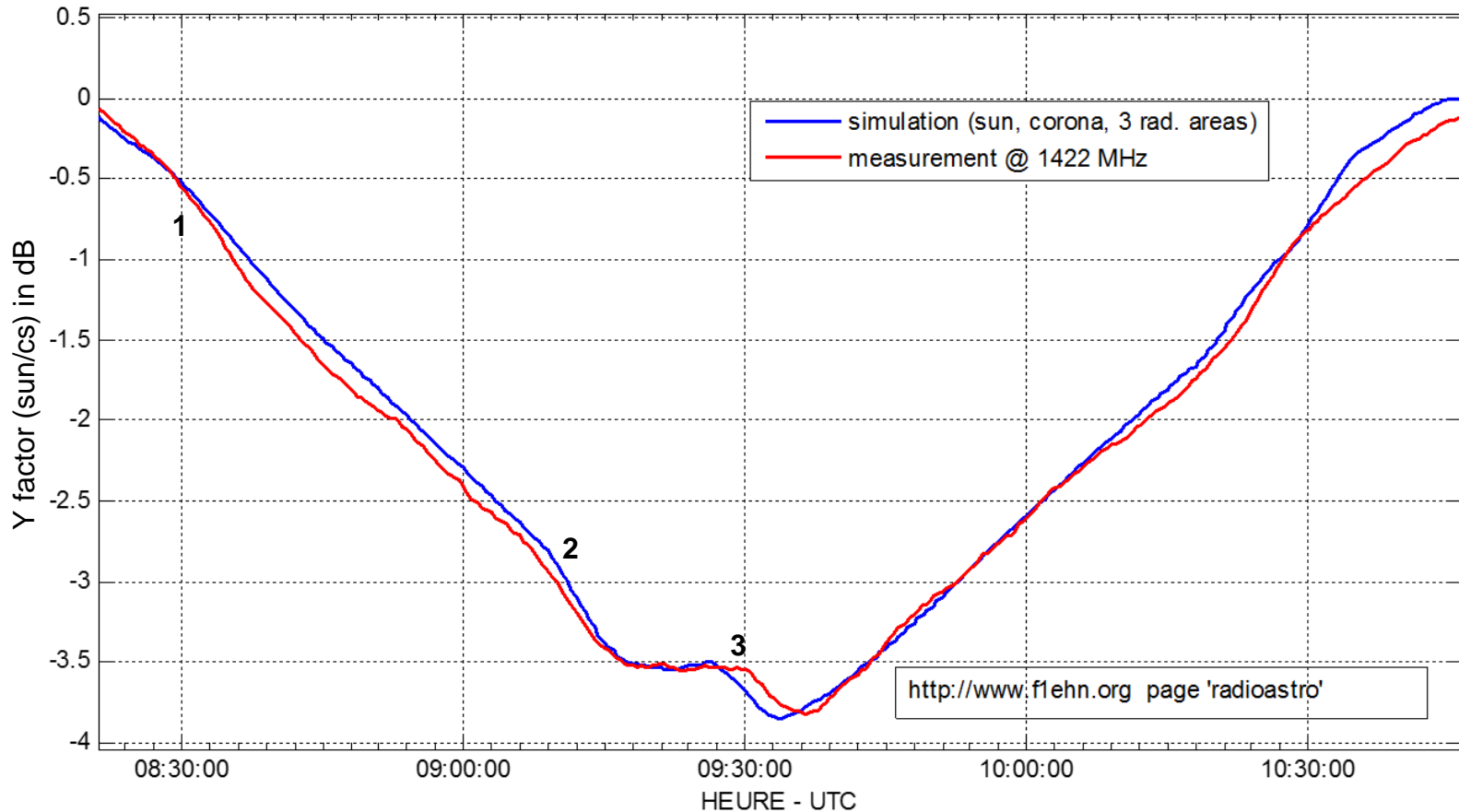

Conclusions

- Originally, during the preparations, this observation seemed relatively simple and easy to understand.
- From the 1st moment of observations it was clear that this was not so. The eclipse began earlier, observed curve was not smooth, the maximum was not on time and the received signal was stronger than expected.
- We made a complex observation which reflects the complexity of the Sun.
- The analyses made possible by other observations with those of Joachim DF3GJ (DL0SHF) have allowed better understanding of the phenomenon observed through many exchanges. We were thus able to develop various reports but leading to very similar conclusions.
- The simulations are designed to explain the observation made but they cannot be considered as a final and accurate result. For this, it would require more information and observations. The Sun is a very active area and radiating areas considered may be more numerous, of different shapes and evolve over the duration of longtime observation for certain phenomena (like bursts).

Conclusions

- For some observers, using a narrower antenna aperture, results may be different due to the occultation of the point sources taking place at different times.
- Different materials or elements used are referenced (see following pages).
- Unfortunately, it will be difficult to reproduce such experience in the future as it will need the relocation of the antenna in another country. However, this shows that the observation of the sun always brings new surprises and continuous, stable and well calibrated observations must be made and plenty of time spent to analyse and reveal all this complexity. This is the difficulty of the exercise of radio astronomy.
- Thanks to the AAV members who participated in this experience as well as J-P F1OI and OBSPM contacts for different exchanges.

References

- Sun – Wikipedia : <http://en.wikipedia.org/wiki/Sun>
- Joachim Köppen DF3GJ / DL0SHF
 - Simulation tool : <http://sat-sh.lernnetz.de/applets/RadioEclipse/index.html>
 - DL0SHF : <http://sat-sh.lernnetz.de/indexEE.html>
 - Observation : <http://sat-sh.lernnetz.de/pdf/Eclipse2015.pdf>
 - Analyses : <http://sat-sh.lernnetz.de/pdf/EclipseAnalysis.pdf>
- CLIMSO :
 - Solar imagery
 - <http://climso.fr/en/>
- Observatoire de Paris (OBSPM)
 - Database BASS2000
 - <http://bass2000.obspm.fr/home.php>
 - video
 - ftp://ftpbass2000.obspm.fr/pub/climso/film/1503/imoa_video_512_00C1_20150320.mpg
 - ftp://ftpbass2000.obspm.fr/pub/climso/film/1503/imoa_video_512_00L1_20150320.mpg
- RATAN-600
 - <http://www.sao.ru/Doc-en/SciNews/2015/eclipse2015/>
 - <http://www.sao.ru/>
- Tracking (Automatic tracking and Planner for simulation forecast)
 - EME System
 - <http://www.f1ehn.org>

References

- Coutrez – “Radioastronomie”

- Solar brightness temperature over different frequencies

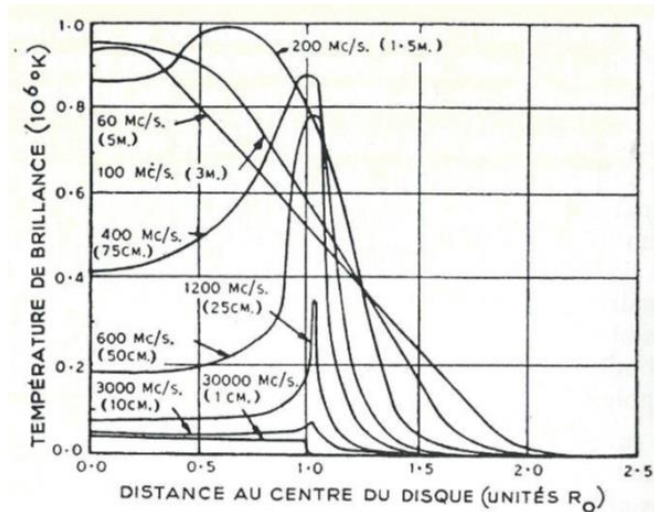

- Simulations – Model and numerical data

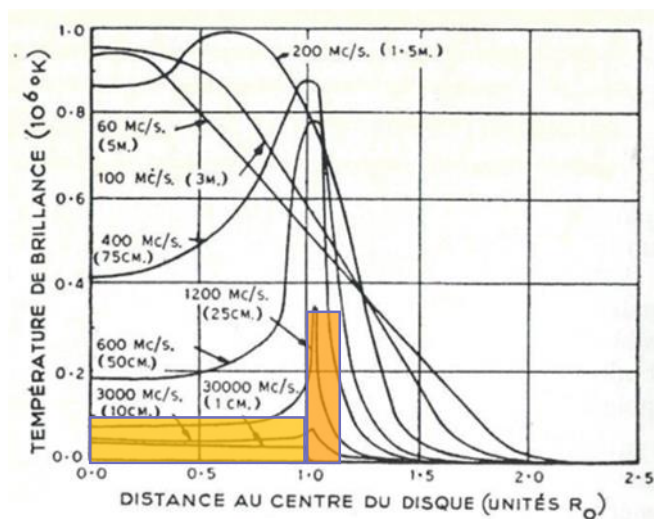

Moon radius : 0.275°
 Sun corona outer radius : 0.325° (1.2 * sun rad.)
 Sun corona inner radius : 0.263°

Burst n°	Radius	Azim offset	Elev offset
1	0,045	+ 0,30	-0,05
2	0,030	- 0,17	+0,21
3	0,027	- 0,31	-0,01

References

- eclipse magnitude - Eclipse magnitude is the fraction of the Sun's diameter occulted by the Moon. It is strictly a ratio of diameters and should not be confused with eclipse obscuration, which is a measure of the Sun's surface area occulted by the Moon. Eclipse magnitude may be expressed as either a percentage or a decimal fraction (e.g., 50% or 0.50). By convention, its value is given at the instant of greatest eclipse.
- eclipse obscuration - Eclipse obscuration is the fraction of the Sun's area occulted by the Moon. It should not be confused with eclipse magnitude, which is the fraction of the Sun's diameter occulted by the Moon. Eclipse obscuration may be expressed as either a percentage or a decimal fraction (e.g., 50% or 0.50).
- <http://eclipse.gsfc.nasa.gov/SEgoogle/SEgoogle2001/SE2015Mar20Tgoogle.html>



References

- DL0SHF

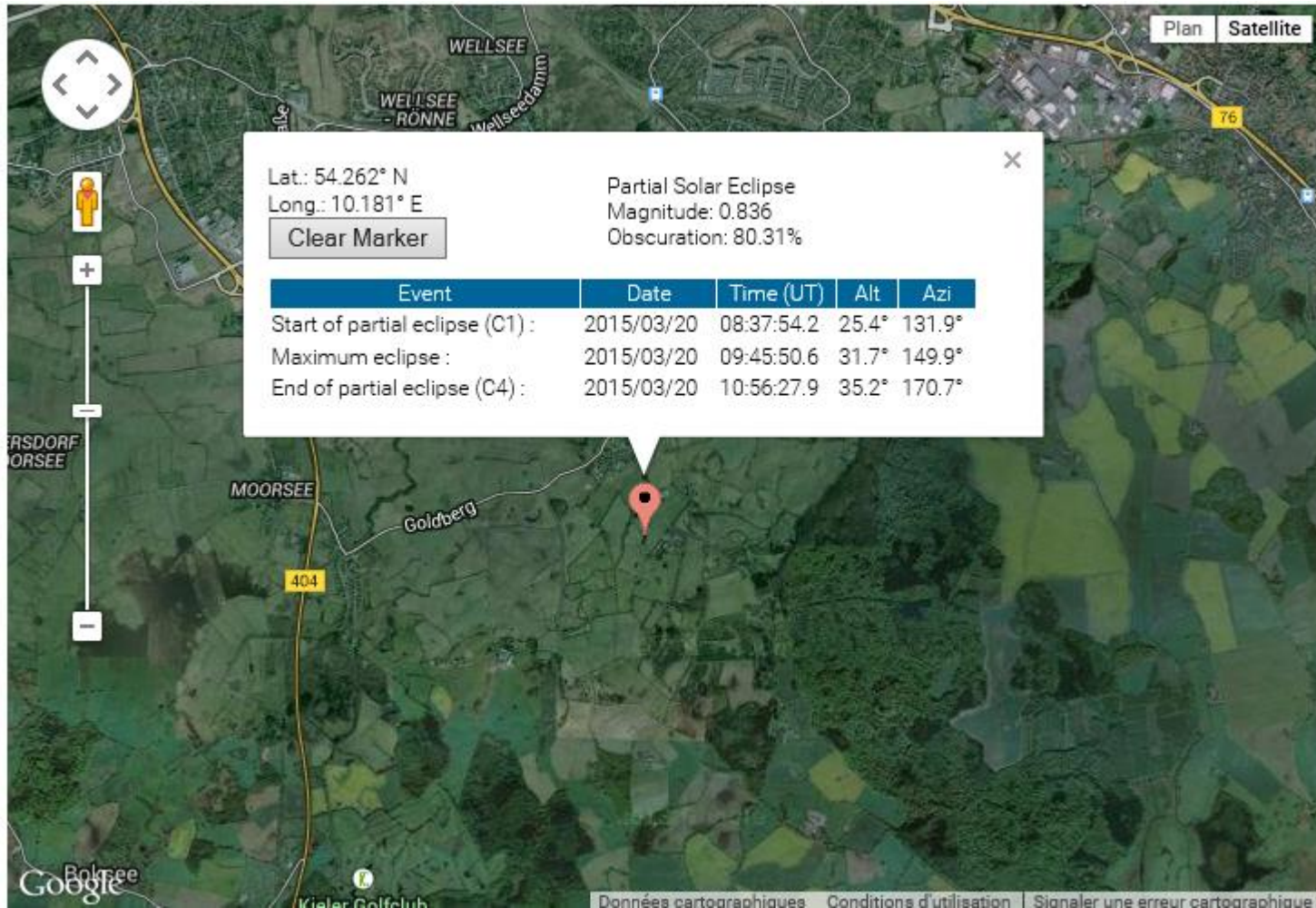

References

- RATAN-600

